

Three Phase Bridge Rectifiers

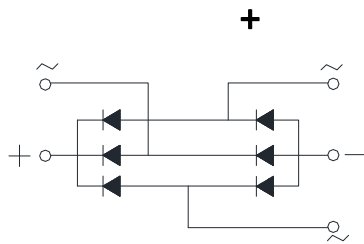
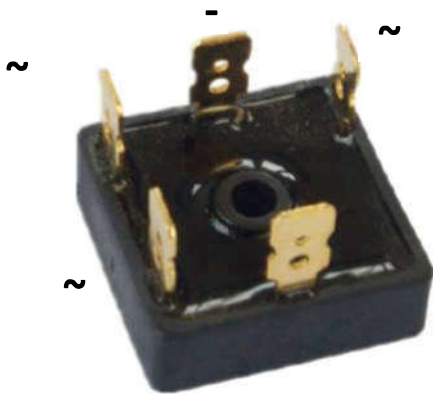

Features

- Glass passivated chip
- High surge current capability
- Low thermal resistance
- Solder dip 275 °C max. 7 s, per JESD 22-B106

Typical Applications

General purpose use in AC/DC bridge full wave rectification for power supply, home appliances, office equipment, industrial automation applications.

Mechanical Data

- **Package:** MT
Molding compound meets UL 94 V-0 flammability rating, RoHS-compliant
- **Terminals:** Tin plated leads, solderable per J-STD-002 and JESD22-B102

■ Maximum Ratings ($T_a=25^{\circ}\text{C}$ Unless otherwise specified)

PARAMETER	SYMBOL	UNIT	MT3504A	MT3506A	MT3508A	MT3510A	MT3512A	MT3514A	MT3516A
Device marking code			MT3504A	MT3506A	MT3508A	MT3510A	MT3512A	MT3514A	MT3516A
Repetitive Peak Reverse Voltage	VRRM	V	400	600	800	1000	1200	1400	1600
Average Rectified Output Current @60Hz sine wave, R-load, With heatsink, $T_c=55^{\circ}\text{C}$	I_O	A	35						
Surge(Non-repetitive)Forward Current @60Hz Half- sine Wave, 1 cycle, $T_a=25^{\circ}\text{C}$	IFSM	A	400						
Current Squared Time @1ms $\leq t \leq 8.3\text{ms}$ $T_j=25^{\circ}\text{C}$, Rating of per diode	I^2t	A^2S	660						
Storage Temperature	T_{stg}	$^{\circ}\text{C}$	-55~+150						
Junction Temperature	T_j	$^{\circ}\text{C}$	-55 ~+150						
Dielectric Strength, Terminals to case, AC 1 minute	Vdis	KV	2.5						
Mounting Torque	TOR	kg·cm	10						

■ Electrical Characteristics ($T_a=25^{\circ}\text{C}$ Unless otherwise specified)

PARAMETER	SYMBOL	UNIT	TEST CONDITIONS	MT3504A	MT3506A	MT3508A	MT3510A	MT3512A	MT3514A	MT3516A
Maximum instantaneous forward voltage drop per diode	VFM	V	IFM=17.5A	1.2						
Maximum DC reverse current at rated DC blocking voltage per diode	IRRM	μA	VRM=VRRM	10						

■ Thermal Characteristics ($T_a=25^{\circ}\text{C}$ Unless otherwise specified)

PARAMETER	SYMBOL	UNIT	MT3504A	MT3506A	MT3508A	MT3510A	MT3512A	MT3514A	MT3516A
Thermal Resistance Between junction and case, With heatsink	$R_{\theta J-C}$	$^{\circ}\text{C}/\text{W}$	1.3						



MT3504A THRU MT3516A

Ordering Information (Example)

PREFERRED P/N	PACKAGE CODE	UNIT WEIGHT(g)	MINIMUM PACKAGE(pcs)	INNER BOX QUANTITY(pcs)	OUTER CARTON QUANTITY(pcs)	DELIVERY MODE
MT3504A~MT3516A	A1	Approximate 17.5	50	50	500	Paper Box

Characteristics (Typical)

FIG1:Io-Tc Curve

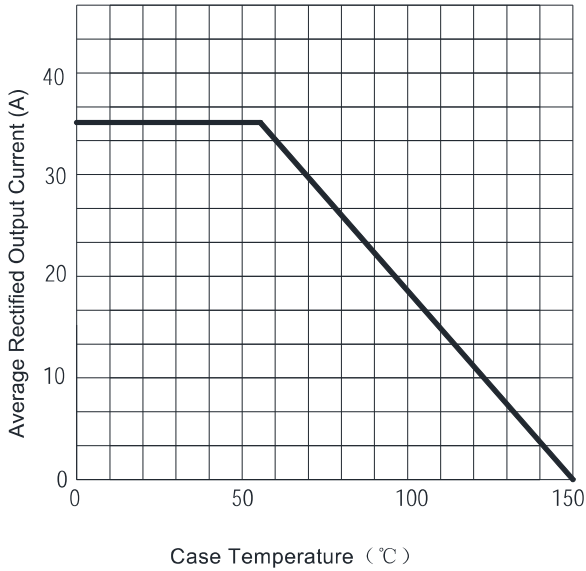

FIG2:Surge Forward Current Capability

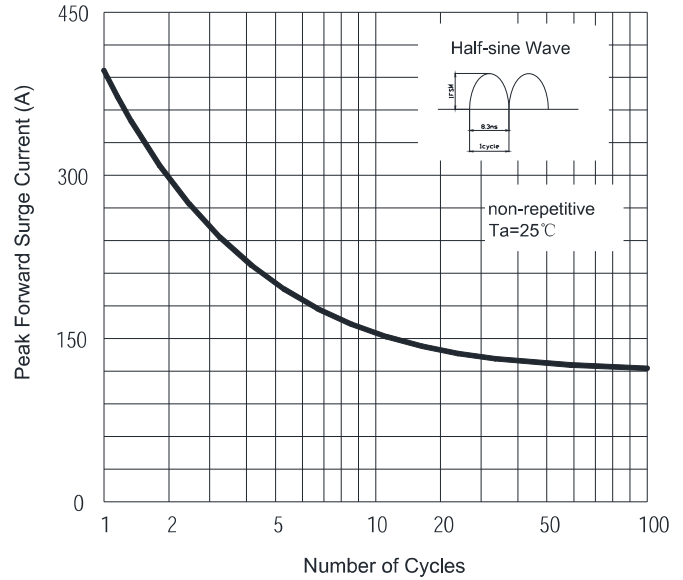

FIG3:Instantaneous Forward Voltage

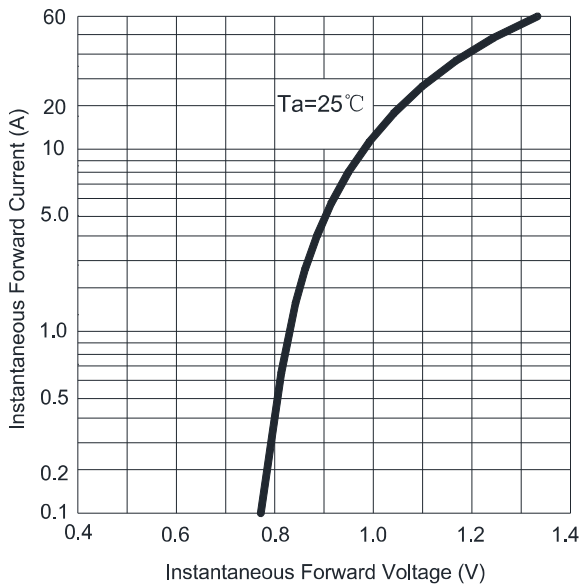
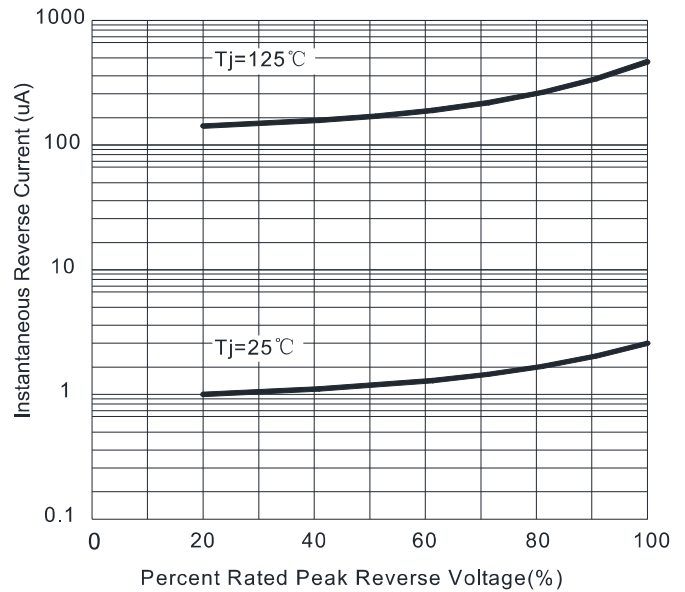
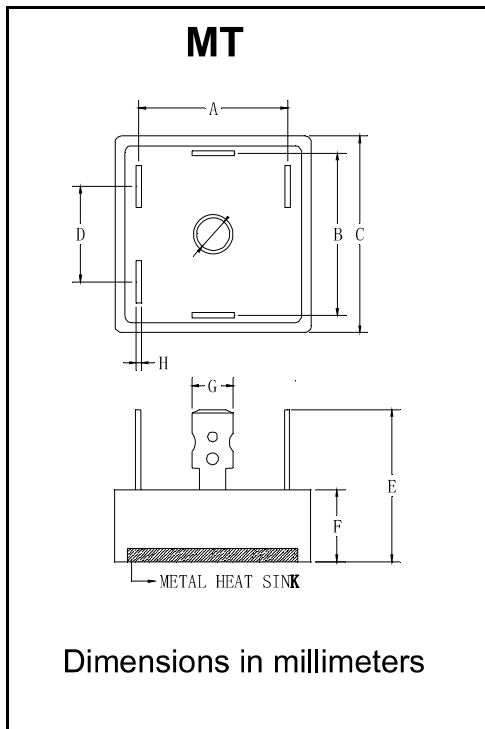

FIG4:Typical Reverse Characteristics



■ Outline Dimensions



MT		
Dim	Min	Max
A	23.3	24.3
B	23.3	24.3
C	28.2	28.8
D	15.5	16.5
E	/	25
F	9	10
G	6.2	6.4
H	0.75	0.85



MT3504A THRU MT3516A

Disclaimer

The information presented in this document is for reference only. shenzhen zenivo Electronic Technology Co., Ltd. reserves the right to make changes without notice for the specification of the products displayed herein to improve reliability, function or design or otherwise.

The product listed herein is designed to be used with ordinary electronic equipment or devices, and not designed to be used with equipment or devices which require high level of reliability and the malfunction of which would directly endanger human life (such as medical instruments, transportation equipment, aerospace machinery, nuclear-reactor controllers, fuel controllers and other safety devices), zenivo or anyone on its behalf, assumes no responsibility or liability for any damages resulting from such improper use of sale.

This publication supersedes & replaces all information previously supplied. For additional information, please visit our website [http:// www.zvelec.com](http://www.zvelec.com) , or consult your nearest zenivo's sales office for further assistance.